

676CT080-40CF HYGIENICPRO CHANNEL 150x8000 CENTER OUTLET

- Low model. With outlet box
- Floor: concrete, tiled and resin
- No membrane
- Outlet: Ø110mm, horizontal
- Stainless steel: AISI304/EN1.4301

Product Codes

UPC/EAN: 5705499137484
VVS Number: 221801380
RSK Number:
NRF Number:
LVI Number: 3305731

Specification

Brand Name: BLÜCHER
Floor: Concrete/tiled/resin
Material: AISI 304
Material (EN): EN 1.4301
Membrane Type: No membrane
Minimum Height (mm): 319
Outlet Box: Yes
Outlet Diameter (mm): 110
Outlet Direction: Horizontal
Outlet Placement: Center
Series: Channel-No membrane
Size: 150x8000
Type: Channels
Weight (kg): 63,14

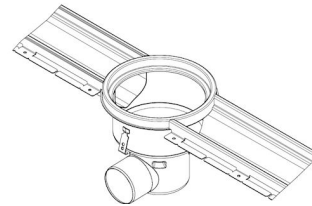
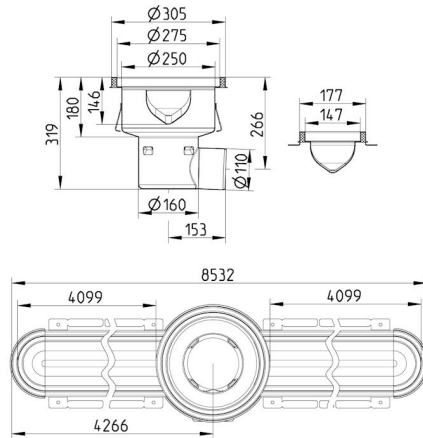

BLÜCHER®

A WATTS Brand