

## 676CT030-15CF HYGIENICPRO CHANNEL 150x3000 CENTER OUTLET

- Low model. With outlet box
- Floor: concrete, tiled and resin
- No membrane
- Outlet: Ø110mm, horizontal
- Stainless steel: AISI304/EN1.4301

### Product Codes

UPC/EAN: 5705499136876  
VVS Number: 221801330  
RSK Number:  
NRF Number:  
LVI Number: 3305721

### Specification

Brand Name: BLÜCHER  
Floor: Concrete/tiled/resin  
Material: AISI 304  
Material (EN): EN 1.4301  
Membrane Type: No membrane  
Minimum Height (mm): 299  
Outlet Box: Yes  
Outlet Diameter (mm): 110  
Outlet Direction: Horizontal  
Outlet Placement: Center  
Series: Channel-No membrane  
Size: 150x3000  
Type: Channels  
Weight (kg): 26,08

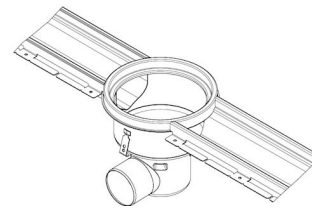
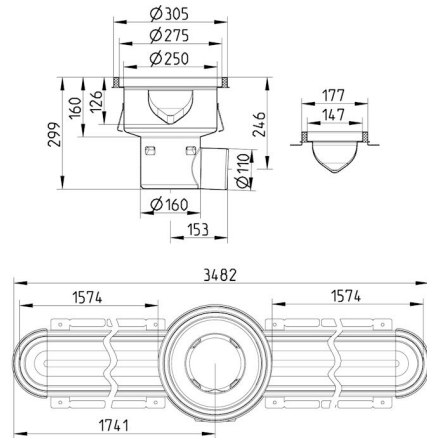

**BLÜCHER®**

A WATTS Brand