

676CC090-45EF HYGIENICPRO CHANNEL 150x9000 CENTER OUTLET

- High model. With outlet box
- Floor: concrete, tiled and resin
- No membrane
- Outlet: Ø110mm, vertical
- Stainless steel: AISI304/EN1.4301

Product Codes

UPC/EAN: 5705499137583
VVS Number: 221801290
RSK Number:
NRF Number:
LVI Number: 3305709

Specification

Brand Name: BLÜCHER
Floor: Concrete/tiled/resin
Material: AISI 304
Material (EN): EN 1.4301
Membrane Type: No membrane
Minimum Height (mm): 565
Outlet Box: Yes
Outlet Diameter (mm): 110
Outlet Direction: Vertical
Outlet Placement: Center
Series: Channel-No membrane
Size: 150x9000
Type: Channels
Weight (kg): 64,20

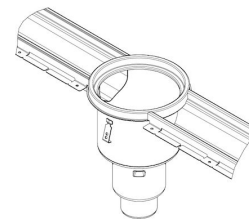
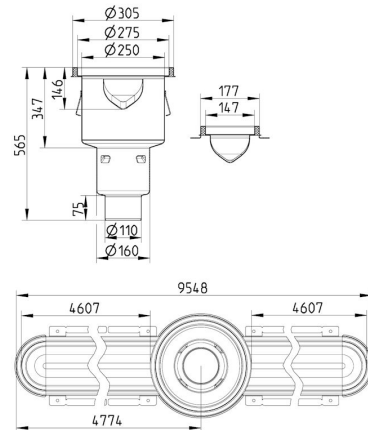

BLÜCHER®

A WATTS Brand