

## 676CC070-35CF HYGIENICPRO CHANNEL 150x7000 CENTER OUTLET

- Low model. With outlet box
- Floor: concrete, tiled and resin
- No membrane
- Outlet: Ø110mm, vertical
- Stainless steel: AISI304/EN1.4301

### Product Codes

UPC/EAN: 5705499137293  
VVS Number: 221801070  
RSK Number:  
NRF Number:  
LVI Number: 3305693

### Specification

Brand Name: BLÜCHER  
Floor: Concrete/tiled/resin  
Material: AISI 304  
Material (EN): EN 1.4301  
Membrane Type: No membrane  
Minimum Height (mm): 398  
Outlet Box: Yes  
Outlet Diameter (mm): 110  
Outlet Direction: Vertical  
Outlet Placement: Center  
Series: Channel-No membrane  
Size: 150x7000  
Type: Channels  
Weight (kg): 56,92

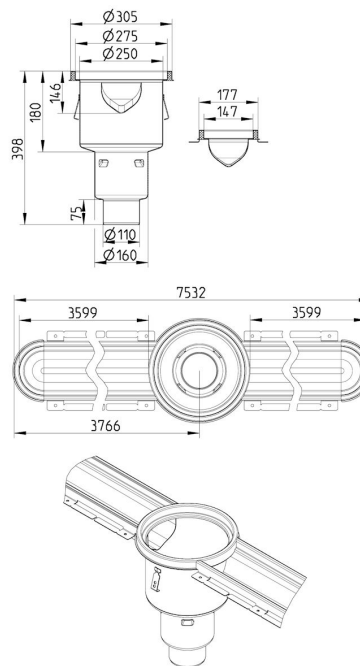

**BLÜCHER®**

A WATTS Brand