

## 676CC060-30DF S HYGIENICPRO CHANNEL 150x6000 CENTER OUTLET

- Medium model. With outlet box
- Floor: concrete, tiled and resin
- No membrane
- Outlet: Ø110mm, vertical
- Stainless steel: AISI316L/EN1.4404

### Product Codes

UPC/EAN: 5705499137200

VVS Number:

RSK Number:

NRF Number:

LVI Number: 3305690

### Specification

Brand Name: BLÜCHER

Floor: Concrete/tiled/resin

Material: AISI 316L

Material (EN): EN 1.4404

Membrane Type: No membrane

Minimum Height (mm): 480

Outlet Box: Yes

Outlet Diameter (mm): 110

Outlet Direction: Vertical

Outlet Placement: Center

Series: Channel-No membrane

Size: 150x6000

Type: Channels

Weight (kg): 51,11

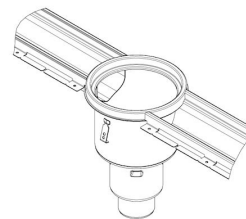
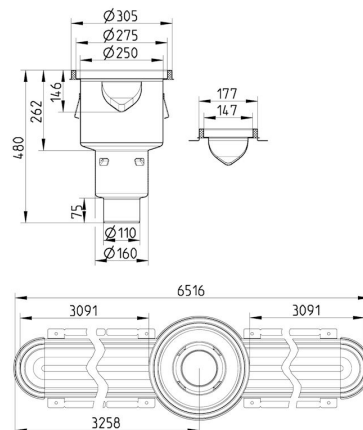

**BLÜCHER®**

A WATTS Brand