

## 676CC020-10DF S HYGIENICPRO CHANNEL 150x2000 CENTER OUTLET

- Medium model. With outlet box
- Floor: concrete, tiled and resin
- No membrane
- Outlet: Ø110mm, vertical
- Stainless steel: AISI316L/EN1.4404

### Product Codes

UPC/EAN: 5705499136722  
VVS Number:  
RSK Number:  
NRF Number:  
LVI Number: 3305666

### Specification

Brand Name: BLÜCHER  
Floor: Concrete/tiled/resin  
Material: AISI 316L  
Material (EN): EN 1.4404  
Membrane Type: No membrane  
Minimum Height (mm): 460  
Outlet Box: Yes  
Outlet Diameter (mm): 110  
Outlet Direction: Vertical  
Outlet Placement: Center  
Series: Channel-No membrane  
Size: 150x2000  
Type: Channels  
Weight (kg): 20,61

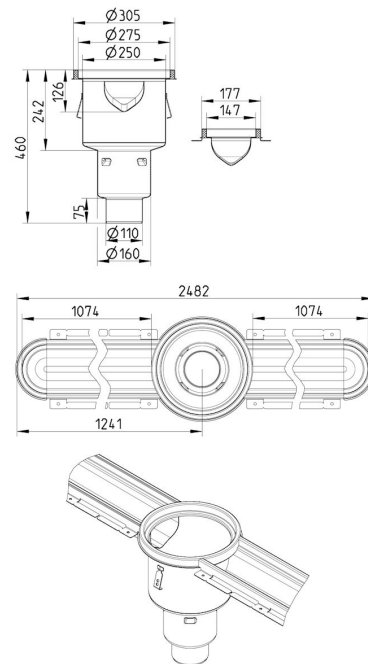

**BLÜCHER®**

A WATTS Brand