

676CC020-00CF HYGIENICPRO CHANNEL 150x2000 END OUTLET

- Low model. With outlet box
- Floor: concrete, tiled and resin
- No membrane
- Outlet: Ø110mm, vertical
- Stainless steel: AISI304/EN1.4301

Product Codes

UPC/EAN: 5705499135732
VVS Number: 221800020
RSK Number:
NRF Number:
LVI Number: 3305633

Specification

Brand Name: BLÜCHER
Floor: Concrete/tiled/resin
Material: AISI 304
Material (EN): EN 1.4301
Membrane Type: No membrane
Minimum Height (mm): 378
Outlet Box: Yes
Outlet Diameter (mm): 110
Outlet Direction: Vertical
Outlet Placement: End
Series: Channel-No membrane
Size: 150x2000
Type: Channels
Weight (kg): 19,42

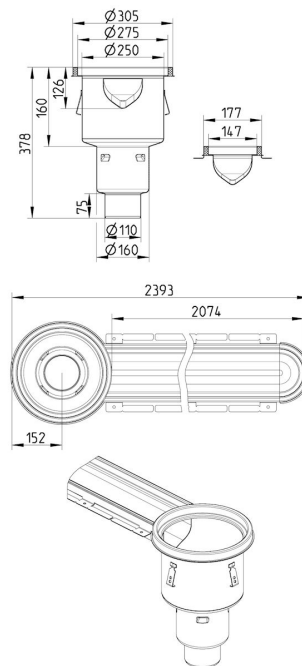

BLÜCHER®

A WATTS Brand