

676CC010-05DF HYGIENICPRO CHANNEL 150x1000 CENTER OUTLET

- Medium model. With outlet box
- Floor: concrete, tiled and resin
- No membrane
- Outlet: Ø110mm, vertical
- Stainless steel: AISI304/EN1.4301

Product Codes

UPC/EAN: 5705499136593
VVS Number: 221801110
RSK Number:
NRF Number:
LVI Number: 3305659

Specification

Brand Name: BLÜCHER
Floor: Concrete/tiled/resin
Material: AISI 304
Material (EN): EN 1.4301
Membrane Type: No membrane
Minimum Height (mm): 460
Outlet Box: Yes
Outlet Diameter (mm): 110
Outlet Direction: Vertical
Outlet Placement: Center
Series: Channel-No membrane
Size: 150x1000
Type: Channels
Weight (kg): 13,60

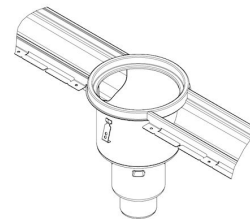
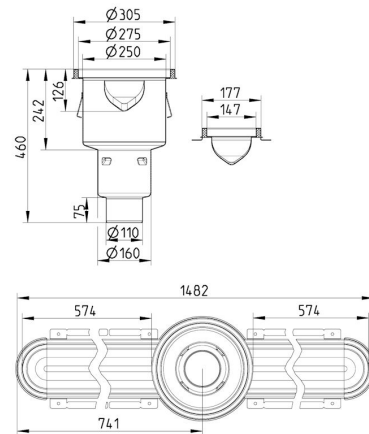

BLÜCHER®

A WATTS Brand