

676CC010-00EF S HYGIENICPRO CHANNEL 150x1000 END OUTLET

- High model. With outlet box
- Floor: concrete, tiled and resin
- No membrane
- Outlet: Ø110mm, vertical
- Stainless steel: AISI316L/EN1.4404

Product Codes

UPC/EAN: 5705499135541
VVS Number:
RSK Number:
NRF Number:
LVI Number: 3305626

Specification

Brand Name: BLÜCHER
Floor: Concrete/tiled/resin
Material: AISI 316L
Material (EN): EN 1.4404
Membrane Type: No membrane
Minimum Height (mm): 545
Outlet Box: Yes
Outlet Diameter (mm): 110
Outlet Direction: Vertical
Outlet Placement: End
Series: Channel-No membrane
Size: 150x1000
Type: Channels
Weight (kg): 14,82

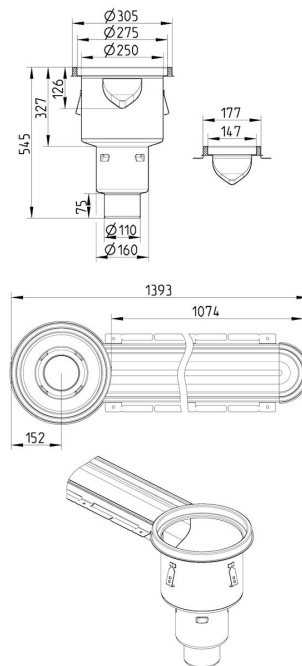

BLÜCHER®

A WATTS Brand