

A

B

C

D

1

2

3

4

1

2

3

4

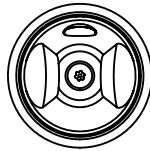
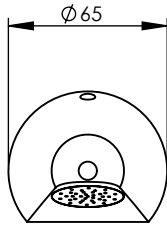
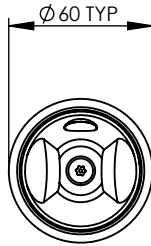
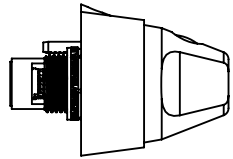
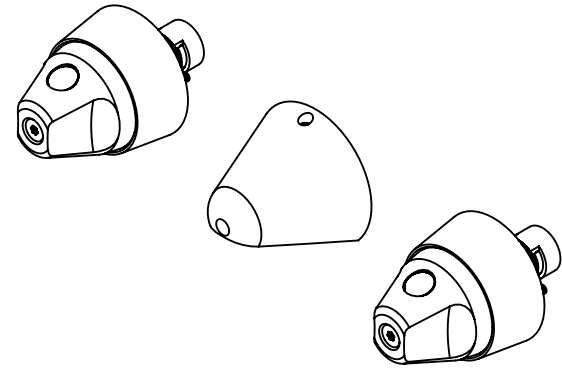
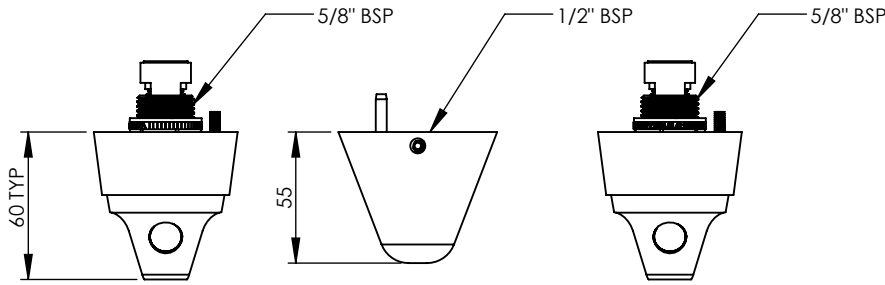

SUPPLIED WITH 1 SCREW
OPTIONAL HOLE FOR
EXTRA SCREW

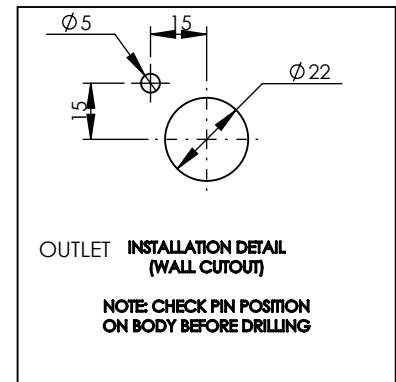
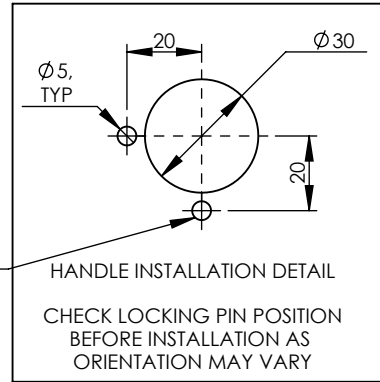

Quality Endorsed Company
AS/NZS ISO 9001
LIC No. 1213
Standards Australia
ENWARE RESERVES THE RIGHT TO
AMMEND PRODUCT
SPECIFICATIONS AND DESIGNS
WITHOUT NOTICE

GENERAL NOTES:
- DIMENSIONS ARE IN mm's
- DO NOT SCALE OFF DIMENSIONS
- TAPWARE TOLERANCE ± 2 (EXCEPT WHERE STATED)
- SAFETY SANITARY AND CARE TOLERANCE ± 5 (EXCEPT WHERE STATED)

This drawing is the property of Enware Australia Pty Ltd and may not be reproduced in full or part without the written consent of Enware Australia.

DRAWN	TD
CHECKED	AC
APPROVED	YK

ENWARE

9 Endeavour Rd,
Caringbah, NSW, 2229 Ph. +61 2 8536 4000
Fax. +61 2 8556 4055

DRAWING NUMBER: **DET354**

REV **A.01**

TITLE:
DET608/DET660 SHOWER SET 8LPM

FINISH: CHROME PLATED

SIZE: A4

SCALE: 1:3

A

B

C

D