

A

B

C

D

1

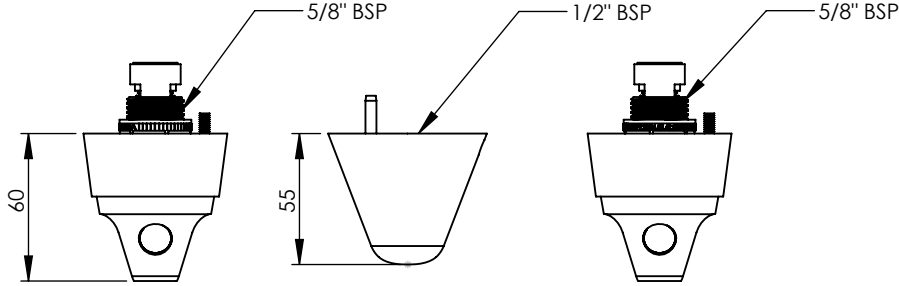

1

2

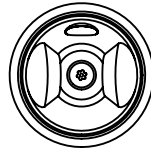
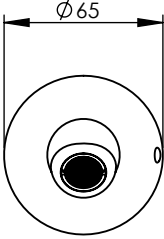
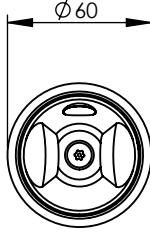
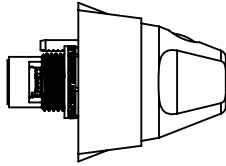

2

3

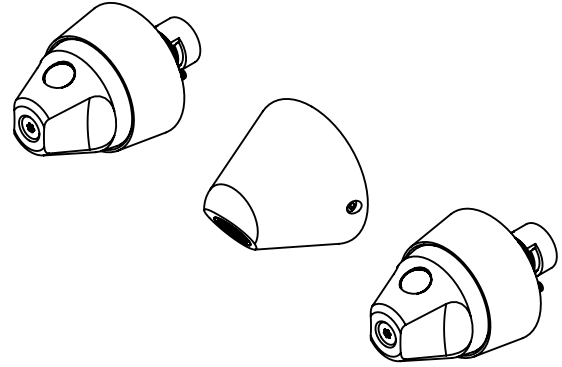

3

4

SUPPLIED WITH 1 SCREW
OPTIONAL HOLE FOR
EXTRA SCREW

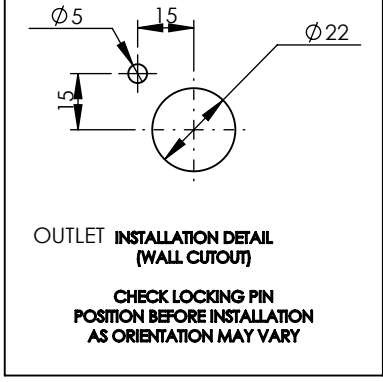
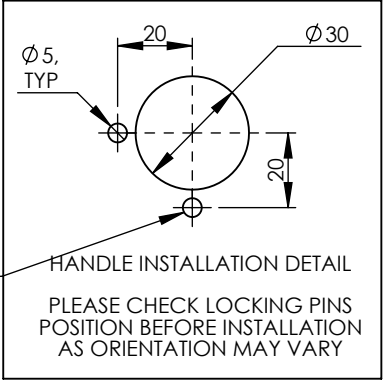

4



GENERAL NOTES:
 - DIMENSIONS ARE IN mm's
 - DO NOT SCALE OFF DIMENSIONS
 - TAPWARE TOLERANCE / 2 (EXCEPT WHERE STATED)
 - SAFETY SANITARY AND CARE TOLERANCE / 5 (EXCEPT WHERE STATED)

This drawing is the property of Enware Australia Pty Ltd and may not be reproduced in full or part without the written consent of Enware Australia.

DRAWN	TD
CHECKED	AC
APPROVED	YK



DRAWING NUMBER: DET314	REV: A.00
DESCRIPTION: DET608/DET660B BASIN/BATH SET 8LPM	
FINISH:	SIZE: A4 SCALE: 1:3

A

B

C

D