

ENWARE TOUCH-FREE WALL SENSOR TAP - ON/OFF DEMAND SENSOR

Installation and Maintenance Instructions



ENM5072A-205 On / Off Demand Stainless Steel Wall Sensor Panel
With 205mm Spout

EMM5072A-250 On / Off Demand Stainless Steel Wall Sensor Panel
With 250mm Spout

I00316_May20

Call 1300 369 273
www.enware.com.au

Enware Australia Pty Limited
9 Endeavour Rd Caringbah NSW 2229 Australia
Ph: 02 8536 4000 info@enware.com.au



product description

Enware Touch-Free Wall Sensor Tap is a sensor operated, hands-free tap that is installed onto walls above sinks, basins or wash troughs. It operates by sensing a hand in front of the sensor unit. Once the sensor is activated, the valve will remain open and water will flow until the hand is again placed in front of the sensor, closing the solenoid valve. It is not necessary for the hand to remain in the beam for the unit to keep the valve open.

If the solenoid valve remains open for more that 45 seconds, the unit will time-out and close the valve automatically. This is intended to conserve water and prevent overflows.

COMPONENTS

The wall sensor tap kit comes standard with a fixed aerated spout, a 1/2" solenoid valve, a sensor panel, a sensor bracket, and a 24 volt DC transformer.

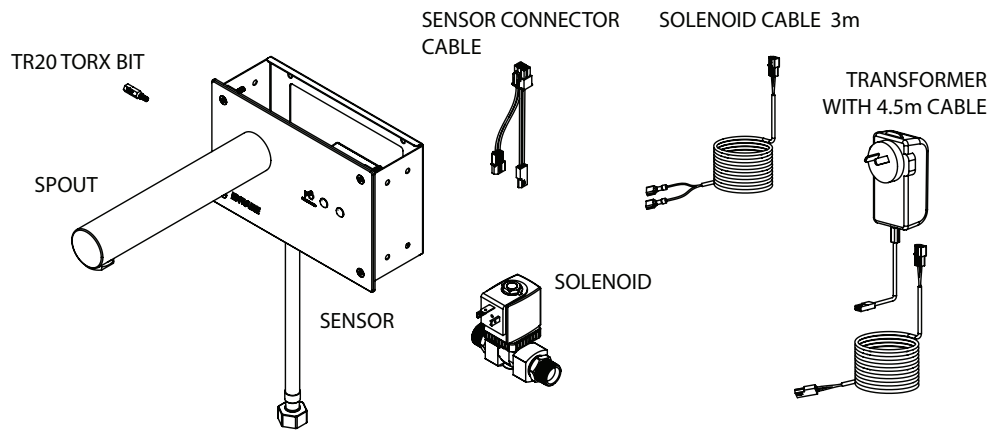

dimensions

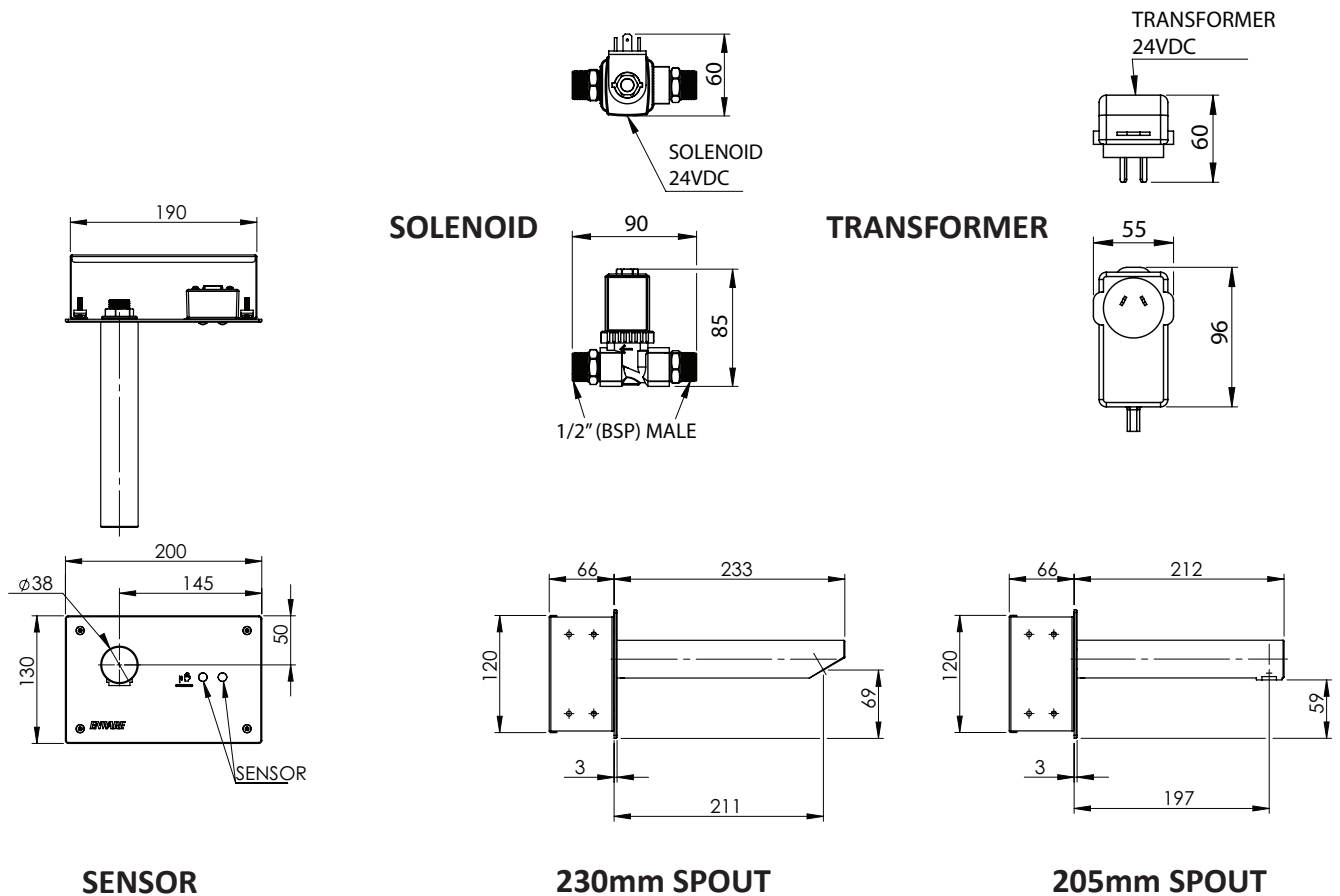

technical data

Inlet Connection	15mm (1/2" BSP)
Recommended Working Pressure Range	100 - 500 kPa*
Flow Rate (Aerator supplied standard with a spout)	4 star (7.7 lpm) WELS rating supplied standard. 6 Star and 5 Star WELS ratings available on request.
Maximum Hot Water Supply Temperature	70 °C *
Operating Voltage	24V DC
Maximum Current	1A
Power Consumption	Less than 10W
Sensor Min / Max Ambient Temperature	Minimum: -5 °C, Maximum: 50 °C
Sensor Protection Rating	IP67 for the front panel and sensor lens. No IP rating behind panel.
Sensor Range	20 - 100mm
Flow time	Place hand in sensor range to activate. Place hand in sensor range again to stop. Maximum of 45 seconds time out per activation.

Optional program settings are available on the following:

- Adjust Minimum Flow Time
- Adjust Maximum Flow Time
- Adjust Sensor Range
- Purge Flush Running Time
- Purge Flush Period Frequency
- Mode – On /Off Demand or Active Sense

The optional settings are available at the time of ordering. Contact Enware for more details.

installation compliance

*Enware products are to be installed in accordance with the Plumbing Code of Australia (PCA) and AS/NZS3500. Installations not complying with PCA and AS/NZS 3500 may void the product and performance warranty provisions.

Reference should also be made to the Australasian Health Facility Guidelines (AHFG), ABCB and Local Government regulations when considering the choice of, and the installation of these products.

This product must be installed and commissioned by a qualified plumber.

For use with potable water only.

NOTE: Enware Australia advises:

1. Due to ongoing Research and Development, specifications may change without notice.
2. Component specifications may change on some export models.



before proceeding with installation

LOCATION OF SENSOR

When selecting a location to install the wall-mounted sensor, consider the following:

OBSTRUCTIONS

Ensure that nothing is within range of the sensor. Any obstruction directly in front of, and within possible range of, the sensor can trigger the sensor randomly or constantly turn it on.

PASSING TRAFFIC

Be sure that passing traffic cannot trigger the sensor. Allow at least 400mm clearance between sensor and passing traffic.

REFLECTIONS AND LIGHTING

If the sensor unit is installed into a location where a nearby wall or object is reflecting the Infrared light back, the unit is effectively blinded and will not operate. Up to 1.5 metre clearance may be necessary from reflective surfaces, such as ceramic tiles and stainless steel, directly in front of, and parallel to, the front face of the sensor. Any bright lighting reflecting off a highly reflective surface such as a stainless steel sink, or a high visibility reflective vest, may also interfere with correct sensor operation.

Do not install sensor directly in front of a mirror.

SET-OUT HEIGHTS

Suggested heights from finished floor:

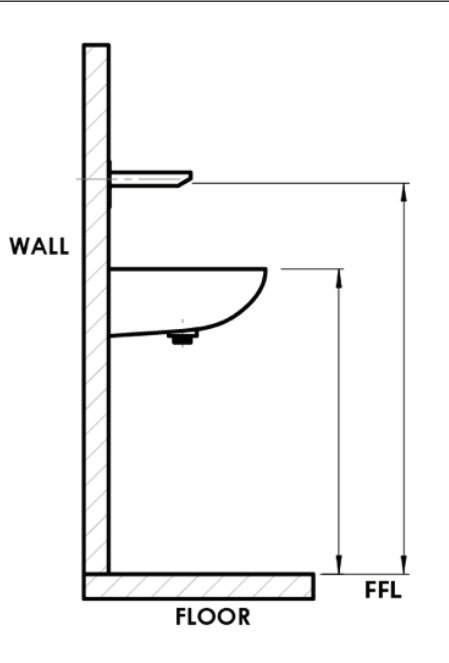
Spout outlet	1050mm	
	1120mm to point of water discharge (Australasian Health Facility Guidelines)	
Top of basin	850mm	
	865mm (Australasian Health Facility Guidelines)	
	800 - 830mm (Reference: AS1428.1-2009)	

before proceeding with installation

ACCESS TO SENSOR TAP COMPONENTS

Ensure that access to the sensor, solenoid valve, transformer/ 240 V power point, and cabling is available for future maintenance when planning or installing assemblies.

- The solenoid valve and power point/ transformer is generally located either in the wall or in the ceiling space but they must be easily accessible for servicing purposes. This may be through an access panel on the wall or the ceiling.
- The cable should be located inside the wall cavity to connect to the power pack lead. All wiring, cables, or leads must be installed in such a way that they can be easily removed and replaced if necessary. It is recommended that all cabling is fed through 20mm conduit to allow for servicing and replacement in future.



WARNING: Do not cut the wires or extend the existing cables without using the correct lead extension from Enware, as this will void warranty.

BEFORE CONNECTING WATER SUPPLY

- Ensure all supply lines are flushed thoroughly to remove debris prior to the installation of this product. Strainers (40 mesh) are recommended if debris is an ongoing problem.
- A pressure reduction valve may be required to comply with the recommended maximum supply pressure and/or balanced pressure requirements.
- Isolation valve and mesh strainer should be fitted before the solenoid, for ease of servicing and trouble-free solenoid operation.

WATER SUPPLY TEMPERATURE

- As the sensor controls a single solenoid valve it is necessary that water temperature and flow are pre-set to the unit. It is recommended that an Aquablend Thermostatic Mixing Valve be used to provide pre-mixed water to the valve.

installation

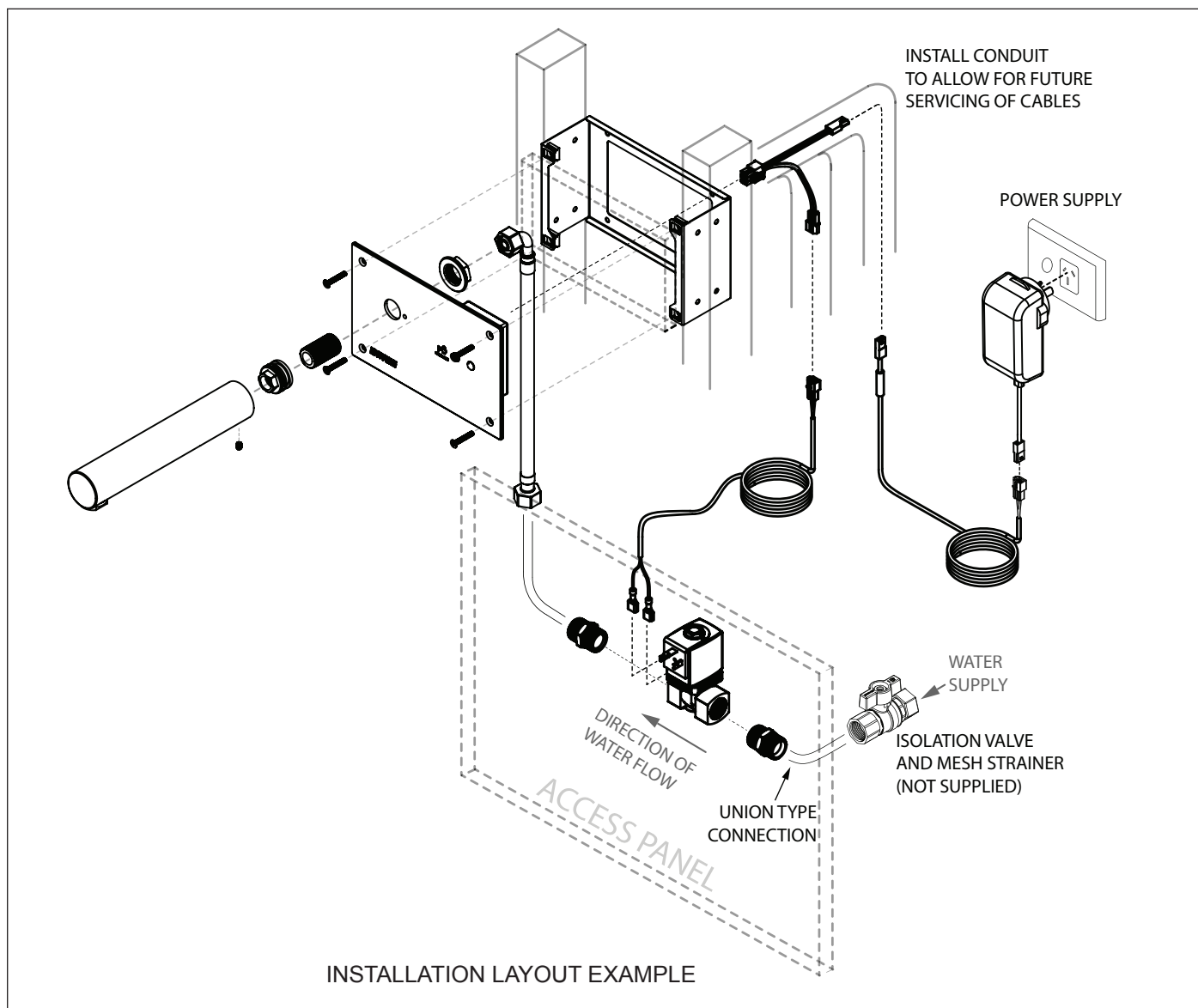

IMAGE 01

installation in-wall

INSTALLING THE SOLENOID

The solenoid valve is installed into the water supply line before the outlet spout. Quick-connect fittings or unions should be fitted on either end of the solenoid, and an isolation valve and a mesh strainer should be fitted before the solenoid, for ease of servicing and trouble-free solenoid operation.

SEE IMAGE 01

installation in-wall

Note: Ensure the solenoid is installed in the correct direction. The arrow on the solenoid body must align with the direction of water flow. **SEE IMAGE 02**

The black casing for solenoid can be turned around to suit the direction of wiring connection, by first loosening the hex nut on top. **SEE IMAGE 03**

Connect outlet line to the outlet side of the solenoid, and supply line to the inlet side of the solenoid. **SEE IMAGE 01**

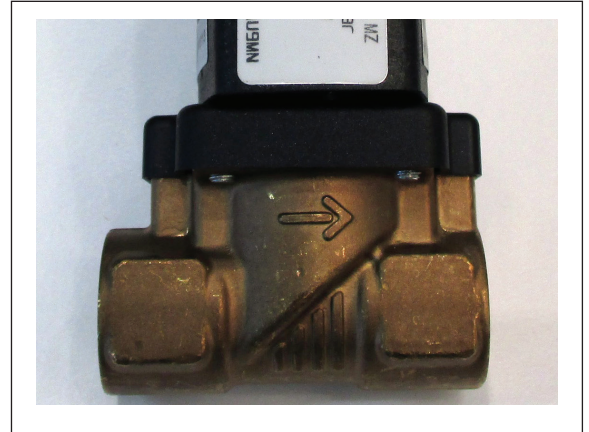

IMAGE 02

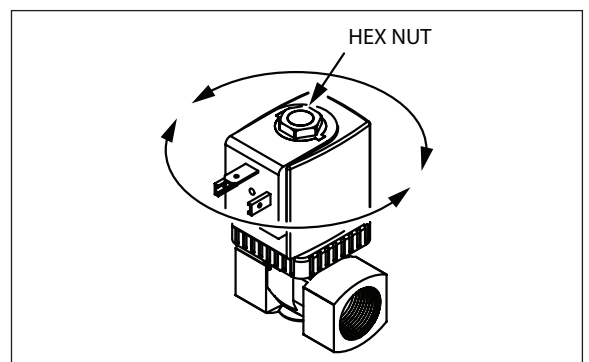

IMAGE 03

INSTALLING THE SENSOR BRACKET

Once the position of the spout and sensor plate is determined, fix the sensor mounting bracket inside wall. Take note of the maximum and minimum depths for the sensor. **SEE IMAGE 04**

Minimum wall depth 65mm, maximum 80mm.

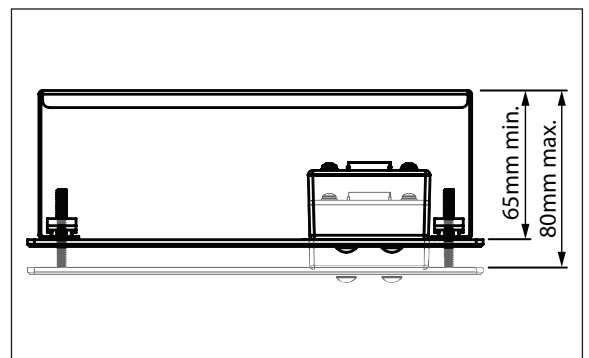

IMAGE 04

Wall Cut Out Dimensions

Before the wall is sheeted or finished, allow for a cut out in the finished wall surface, of 193mm wide x 120mm high rectangular hole, and at least 65mm deep to allow for installation of bracket. Sensor cable to come through the top, bottom, or back of sensor inside wall. **SEE IMAGE 05**

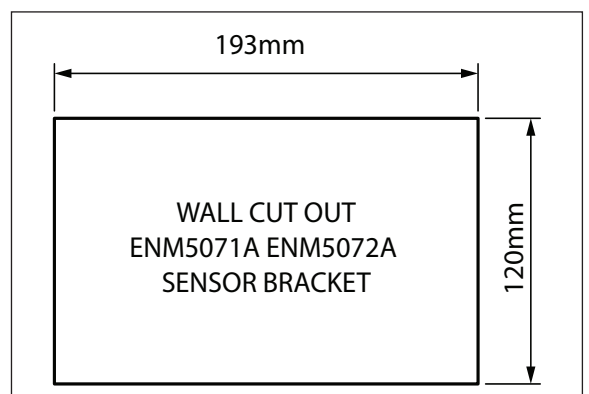

IMAGE 05

installation in-wall

POWER PACK AND CABLES

It is recommended that all cabling is fed through 20mm conduit to make servicing and replacement easier. The solenoid valve and power point/transformer are generally located either in the wall space or in the ceiling but must be easily accessible for servicing. This may be through an access panel on the wall or the ceiling.

The transformer has a 4.5 metre lead to the sensor and the solenoid cable has a 3 metre lead from the sensor to the solenoid. Additional lead lengths up to 15 metres can be accommodated with extension cables (available separately from Enware). **SEE IMAGE 06**



WARNING: Do not cut the electrical cable of the sensor tap, or alter the product in any way to suit installation. Damage caused in this way will void warranty. Cable extensions are available if extra cable length is required. (Refer to Spare Parts Section)

Plug the 24V DC transformer into the 240V AC power point.

Connect Transformer Cable to Sensor Connector Cable.

Connect Solenoid Cable to Sensor Connector Cable. Connect spade connectors to two bottom terminals on solenoid. Do not connect to earth terminal on top. **SEE IMAGE 07**

WARNING: Protecting from Water Spray

Note that the power pack and connections are NOT spray or water proof. If there is a possibility of water coming into contact with any of the electrical components or connections (e.g. if electrical components are exposed underneath a basin), the unit and all of the interconnections should be installed into a water-proof enclosure.

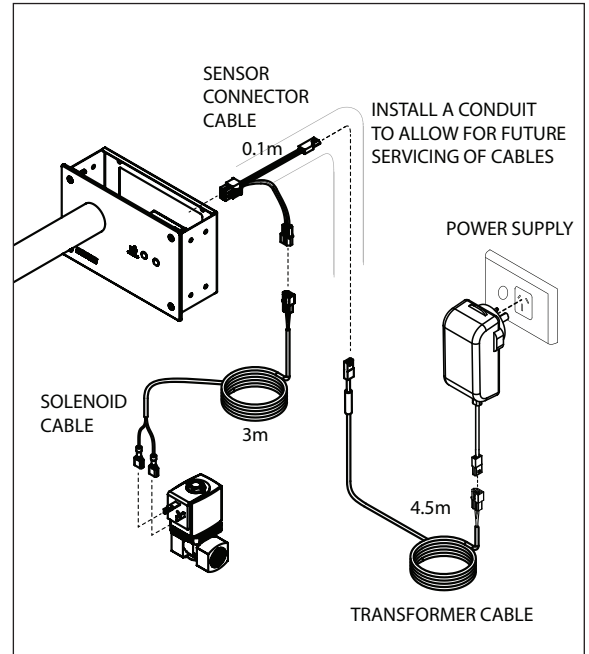

IMAGE 06

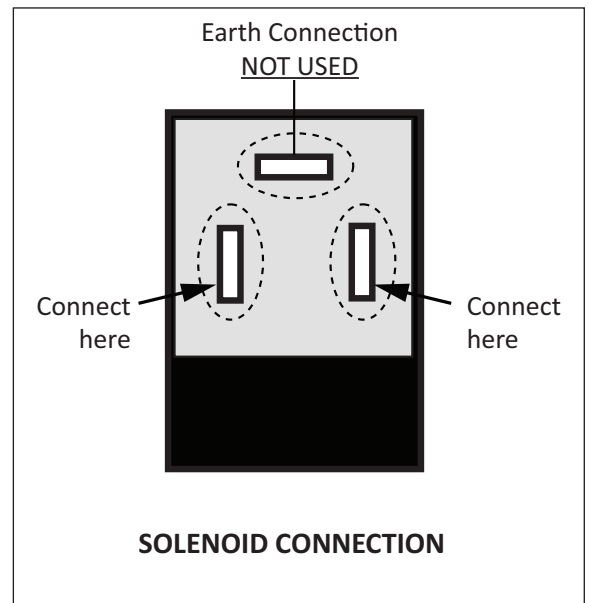

IMAGE 07

installation in-wall

WIRING METHOD SEE IMAGE 06 AND 07

TESTING

Turn the water on and check for leaks. Connect all electrical components together temporarily, and test the tap. Once correct operation of the tap is confirmed, disconnect the sensor plate and turn off the power to the transformer. The tap is now ready for sheeting or finishing of the wall.

installation after the wall is finished

MOUNTING THE SENSOR PLATE

The stainless steel sensor unit is always mounted flush to the wall. Feed the transformer cable through the conduit and make the connection to the sensor by joining the line plug and socket, observing the polarity of the plug.



IMPORTANT:

Before fixing the sensor plate to wall, apply a thin bead of silicone sealant behind the plate along the top and side edges. Ensure that the plate is thoroughly sealed to the wall and that not water can get in behind the plate.

Any water entering behind the sensor plate will cause damage to sensor components and void warranty.

Fix the sensor panel using four screws provided.



WARNING:

Sensor components are fragile and sensitive. Do not force the sensor plate to fit onto wall, or attempt to disassemble sensor components, as this could result in damage to sensor and would void warranty.

INSTALLING THE SPOUT

Apply thread sealant on 1/2" BSP male thread. Screw on the wall base with a spanner and fix onto plate with the back nut. Loosen grub screw on the spout, slide onto wall base, then tighten the grub screw to fix the spout in position.

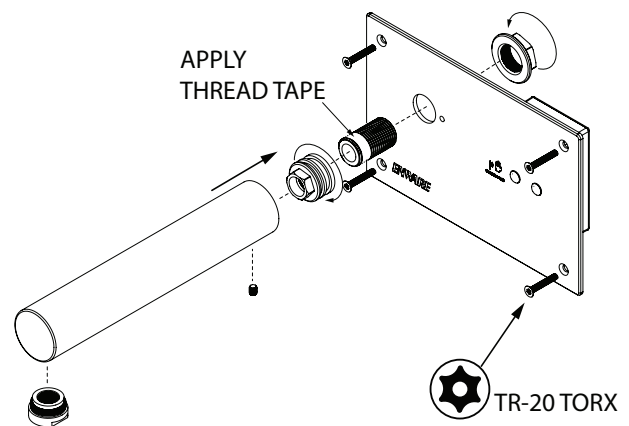

TESTING

Turn on the power to the unit and test the unit. See Operating Instructions overpage.

operating instructions

TO TURN ON

Place hand in front of sensor lens for half a second at a distance of 5 cm. Move hand away. Water starts to flow.

TO TURN OFF

Place hand in front of sensor lens for half a second at a distance of 5 cm. Move hand away. Water flow stops.

If tap is not turned OFF, it will automatically turn OFF after 45 seconds*.

When hand is within sensor range, sensor responds with a Red LED light in the sensor lens.

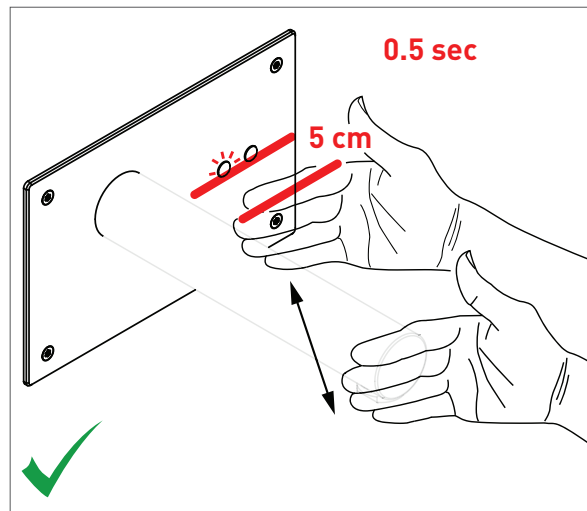

*Longer flow time settings are available – contact Enware for more information.

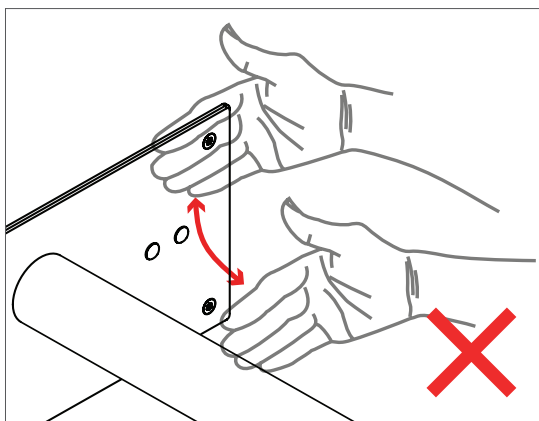

Wave quickly in front of sensor
(does not activate)

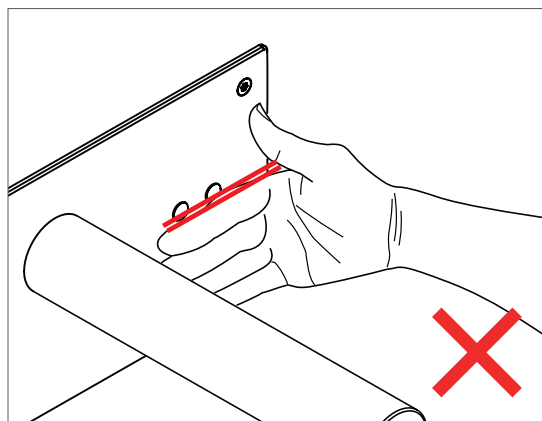

Hand too close to sensor
(does not activate)

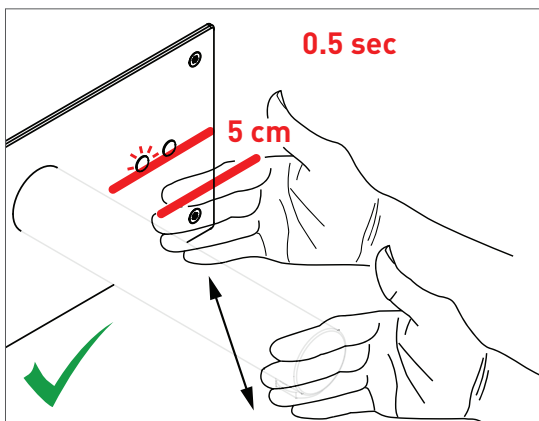

Place hand in front of sensor at
5cm for 0.5 sec

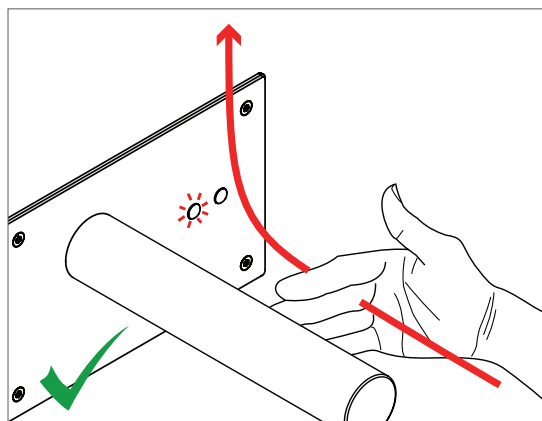







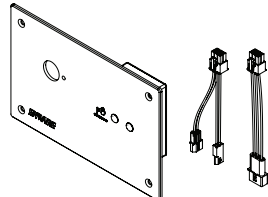
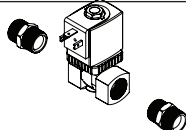
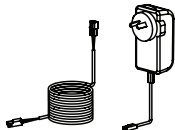

Move hand in towards sensor and
pulling up

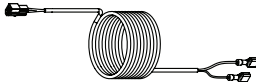
troubleshooting

PROBLEM	CAUSE	RECITIFICATION
Tap/ water continues to flow	Solenoid valve is installed the wrong way round	Re install valve correctly. Check the direction of water flow is with arrow. SEE IMAGE 02
Tap does not turn off	Debris in solenoid valve	Take solenoid apart and clean diaphragm. Refer to Solenoid Maintenance section.
	Solenoid diaphragm is damaged	Replace solenoid diaphragm or solenoid. Refer to Solenoid Maintenance section.
	Seat on solenoid body is damaged	Replace solenoid.
	An object is within sensor range	Remove object in sensor range.
Tap/ water does not turn on when hand is placed in front of sensor	Power supply is off or transformer is damaged	Turn power on or replace transformer
Red LED does not light up in the sensor lens	Sensor is damaged	Replace sensor
Tap/ water does not turn on when hand is placed in front of sensor	Water supply is off or Thermostatic Mixing Valve (TMV) has shut down	Check water supply and / or TMV.
Red LED lights up in the sensor lens	Solenoid cables connected incorrectly	Connect cables correctly. See IMAGE 07
	Solenoid valve is damaged	Replace solenoid valve
Tap/ water turns off slowly	Debris in solenoid valve	Take solenoid apart and clean diaphragm. Refer to Solenoid Maintenance section.
	Solenoid diaphragm is damaged	Replace solenoid diaphragm or solenoid. Refer to Solenoid Maintenance section.

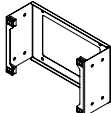
spare parts

PART		ENWARE PRODUCT CODE
Sensor – On / Off Demand (Stainless steel plate, sensor connector cable)		ENMS133A
Solenoid 1/2" – DC 24v (includes DC solenoid 1/2", 2x 1/2" nipples)		WMS8200
Solenoid Service Kit - DC (includes diaphragm, piston and spring to suit DC solenoid 1/2")		WMS8302
Transformer – DC 24v with 1.8m lead		EMDS802
Sensor Connector Cable 0.1m		673830
Solenoid Cable 3m		673829
2m Extension Cable for Transformer or Solenoid		EMDS801
4.5m Extension Cable for Transformer or Solenoid		480222
Spout Aerator (5 Lpm, M24)		672427
Metal Bracket for Sensor Plate		592079
Fixing Screw for Sensor Plate		672480
TR-20 Torx Fixing Screw Bit		672483
205mm Spout		794602
250mm Spout		SPC250

Spare Parts to Suit Old Version ENM5072-205, ENM5072-250 (Pre-2019)

PART	CODE	PART	CODE
Sensor – On / Off Demand, incl. S/S plate, adaptor cable	ENMS133A	2m extension cable for solenoid - spade connectors	EMS814
Solenoid 1/2" - AC 24v, incl. nipples	EMS804	4m extension cable for solenoid - spade connectors	EMS813
Transformer with 1.8m lead AC 24v	EMS805	Solenoid service kit (1/2" AC)	ENMS229
2m extension cable for transformer	EMS840	Spout Aerator (5 Lpm, M24)	672427
4m extension cable for transformer	EMS841		

service & maintenance

SOLENOID MAINTENANCE

For long periods of non-use, a minimum activation of 1-2 times per day is recommended.

High frequency of use and high water supply pressures reduce the service life of a solenoid.

If the solenoid is not working correctly or is leaking, go through the following steps to service the solenoid. The most common cause of solenoid malfunction is debris getting caught inside, in which case the solenoid needs to be dismantled and cleaned. Service kits including replacement diaphragms are available.

TO ACCESS THE SOLENOID VALVE

1. Turn water supply off and activate the sensor to drain water from the line. Turn power off to the sensor.
2. In most cases it is easier to remove the complete solenoid valve from the installation to service it. Remove the electrical connectors from the solenoid terminals, undo the water connections on both the water inlet and outlet of the solenoid, and remove the solenoid.
3. The solenoid can be disassembled and checked for debris or damage to the diaphragm. Refer to "Servicing the Solenoid" instructions below. Take note of the location of the components so that it can be reassembled later in the correct order.
4. Service or replace the solenoid and re-install into the line. Push the cable connectors back onto the solenoid terminals.
5. Turn power and water back on and test the tap.

SERVICING THE SOLENOID

Tools required: Spanner, T20 Torx Bit or Slotted Screw Driver

1. Remove the hex nut located on top of the solenoid.
SEE IMAGE 08
2. Remove the black coil body and plastic cover from the core tube by sliding up. **SEE IMAGE 09**
3. Using a T20 Torx screw driver (star bit) or a slotted screw driver, remove the 4 Torx screws that are holding the core tube. Use the correct size tool and take care not to round the screws heads. Keeping in mind that the plunger inside the core tube is spring loaded, dismantle the valve with care. Take note of the order of parts assembled. **SEE IMAGES 10, 11**
4. Check seat and diaphragm for debris or any damage.
SEE IMAGE 12

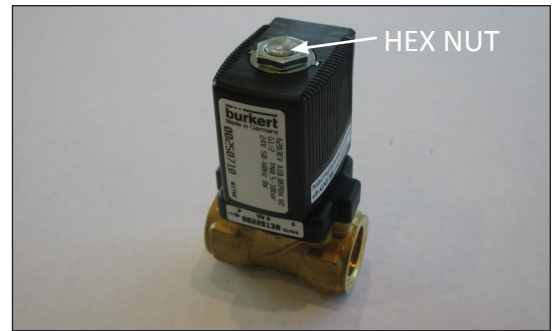

IMAGE 08

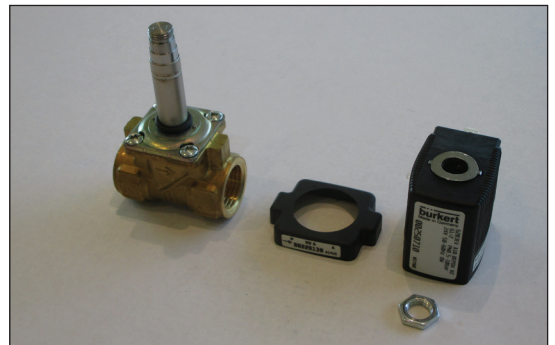

IMAGE 09

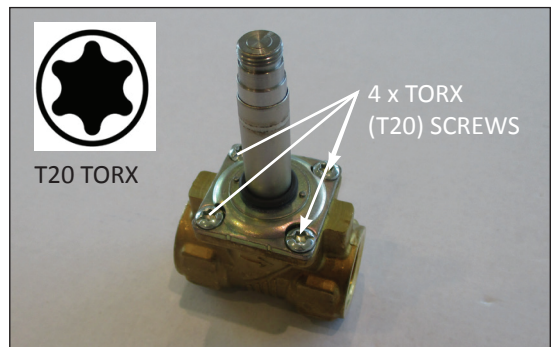

IMAGE 10



IMAGE 11



IMAGE 12

5. Note the small hole in the rubber diaphragm. It is important that this hole is clear and not obstructed by debris. Clean the diaphragm by rinsing with water. **SEE IMAGE 13**
6. Replace any component that is damaged.
(Service Kit code 892028)
7. To reassemble, firstly place the rubber diaphragm in correct position. The hole in the diaphragm should be assembled either at 2 O'clock or 4 O'clock position, when the direction of flow is going from left to right, as shown below. The arrow is indicated on the solenoid body. **SEE IMAGES 14-17**

Note: Do not apply grease to internal components of solenoid. Grease can deteriorate over time and cause the solenoid to malfunction.

8. Reassemble the plunger with spring into the core tube. Check that the spring is reassembled back together inside the core tube, and no foreign material is in the core tube to restrict the plunger movement.
9. Once this is done, place the core tube back on top of the valve and tighten back up with the 4 Torx screws.
10. Once the core tube is tightened, place the plastic cover which goes over the core tube. This covers the screws. When doing so, ensure the sticker on the plastic has the same flow direction as the body.
11. Finally place the black coil body back over the core tube, and tighten the hex nut back up.

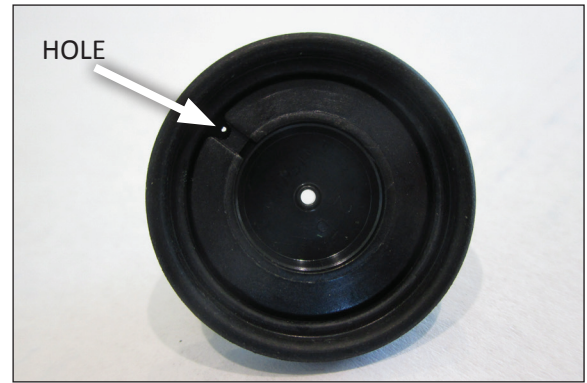

IMAGE 13

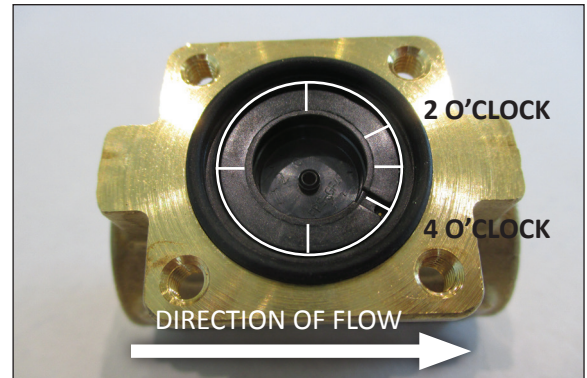

IMAGE 14

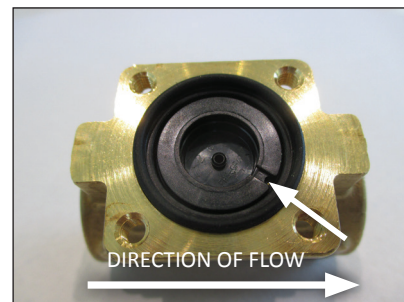

IMAGE 15

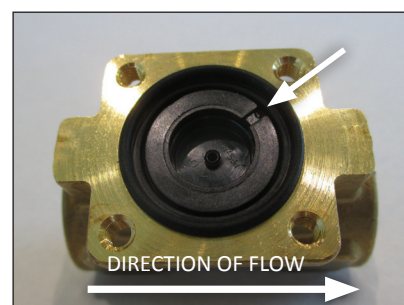

IMAGE 16

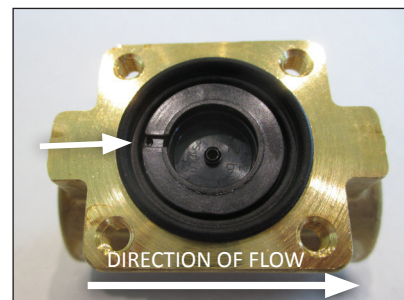

IMAGE 17

REPLACING THE SENSOR

The Sensor is a non-serviceable product. If damaged the sensor must be replaced.

1. Turn power off at the power point.
2. Unscrew the fixing screws from the panel.
The existing silicon seal may have to be cut to free the sensor, do this carefully. All sealing compounds such as silicon should be removed from the wall surface.
3. Pull the sensor out from the mounting block carefully and access the plug and socket connection. Unplug the line plug and socket and leave the cable securely out of the conduit. Replace the transformer or solenoid cable at this time if necessary.
Disconnect spout from water supply and dismantle from sensor plate. Reinstall onto new sensor plate.
4. Connect the new sensor. Feed the cable back into the conduit.
5. Apply a thin bead of silicon sealant on behind the plate along the top and side edges, to seal the unit to the wall.



IMPORTANT:

Before fixing the sensor plate to wall, apply a thin bead of silicone sealant behind the plate along the top and side edges. Ensure that the plate is thoroughly sealed to the wall and that not water can get in behind the plate.

Any water entering behind the sensor plate will cause damage to sensor components and void warranty.

6. Fix the sensor panel back onto the mounting block using the existing screws.

REPLACING THE TRANSFORMER

The Transformer is a non-serviceable product. If damaged the transformer must be replaced.

1. Turn power off at power point and unplug the transformer.
2. The transformer comes standard with 4.5 metres of cable. This cable is connected to the sensor.
3. Take note of the installation, firstly to determine if additional cable extensions are required (additional to the 4.5 metres) and secondly to see if cable access is difficult or if the cable is fed through a conduit. If the cable is in a conduit then a lead or leads may be required to be tied to the existing cable before it is removed so the new cable can be pulled back through.
4. Slowly pull the cable through to the sensor. Remove the old transformer and cable.
5. Connect the new transformer cable to the sensor connector cable. Re-install the sensor.
6. Plug the 24 V DC transformer into the power point.
7. Turn on the power to the unit and test the unit.

CLEANING

Enware Product should be cleaned with a soft damp cloth using only mild liquid detergent or soap and water. Do not use cleaning agents containing a corrosive acid, scouring agent or solvent chemicals. Do not use cream cleaners, as they are abrasive.

Use of unsuitable cleaning agents may damage the surface. Any damage caused in this way will not be covered by warranty.

Enware Australia Pty Limited (ACN 003 988 314) (“we” or “us”) warrants that this product (also referred to as “our goods”) will be free from all defects in materials and workmanship for 12 months from the date of purchase. Our liability under this warranty is limited at our option to the repair or replacement of the defective product or part, the cost of repair of the defective product or part or the supply of an equivalent product or part, in each case if we are satisfied the loss or damage was due to a defect in the materials or workmanship of the product or part. All products must be installed in accordance with the manufacturer’s instructions, the Plumbing Code of Australia (PCA), and AS/NZS3500 including any other applicable regulatory requirements.

making a claim

To make a claim under this warranty you must notify us in writing within 7 days of any alleged defect in the product coming to your attention, provide us with proof of your purchase of the product and have completed the Online Product Service and Warranty Form available on website www.enware.com.au. All notifications and accompanying forms must be sent to us marked for the attention of the Enware Australia Pty Limited, 9 Endeavour Road, Caringbah NSW 2229. We can also be contacted by telephone (1300 369 273) or by email (info@enware.com.au).

Your costs in making a claim under this warranty, including all freight, collection and delivery costs, are to be borne and paid by you. We also reserve the right at our cost to inspect any alleged defect in the product wherever it is located or installed or on our premises.

exceptions

This warranty does not apply in respect of any damage or loss due to or arising from:

- a) Failure by you or any other person to follow any instructions for use (including instructions and directions relating to the handling, storage, installation, fitting, connection, adjustment or repair of the product) published or provided by us;
- b) Failure by you or any other person responsible for the fitting, installation or other work on the product to follow or conform to applicable laws, standards and codes (including the AS/NZ 3500 set of Standards, all applicable State and Territory Plumbing Codes, the Plumbing Code of Australia and directions and requirements of local and other statutory authorities); or
- c) Any act or circumstance beyond our control including faulty installation or connection, accident, abnormal use, acts of God, damage to buildings, other structures or infrastructure and loss or damage during product transit or transportation.

other conditions

Except as provided or referred to in this document, we accept no other or further liability for any damages or loss (including indirect, consequential or economic loss) and whether arising in contract, tort or otherwise. Any benefits available to you under this warranty are in addition to any non-excludable rights or remedies you may have under applicable legislation, including as a “consumer” under the Australian Consumer Law. To that extent you need to be aware that: our goods come with guarantees that cannot be excluded under the Australian Consumer Law. You are entitled to a replacement or refund for a major failure and for compensation for any other reasonably foreseeable loss or damage. You are also entitled to have the goods repaired or replaced if the goods fail to be of acceptable quality and the failure does not amount to a major failure.

ADDRESS: 9 Endeavour Road, Caringbah NSW 2229 Australia

POSTAL ADDRESS: P.O. Box 2545, Taren Point NSW 2229 Australia

PHONE: 61 2 8536 4000 FAX: 61 2 8556 4066

1300 369 273 (AUS) WWW.ENWARE.COM.AU INFO@ENWARE.COM.AU

