

726.403.110 S INDUSTRIAL DRAIN, LOW

- Floor: concrete and tiled
- No membrane, frame: 300x300mm
- Outlet: Ø110mm, horizontal
- Stainless steel: AISI316L/EN1.4404

Product Codes

UPC/EAN: 5705499108910

VVS Number: 153012316

RSK Number:

NRF Number:

LVI Number: 3303656

Specification

Adjustable: No

Brand Name: BLÜCHER

Floor: Concrete/tiled

Material: AISI 316L

Material (EN): EN 1.4404

Membrane Type: No membrane

Minimum Height (mm): 188

Number of Inlets: 0

Number of Screw Holes: 0

Outlet Diameter (mm): 110

Outlet Direction: Horizontal

Series: Drain-No membrane-300

Shape: Square

Size: 300x300

Weight (kg): 4,48

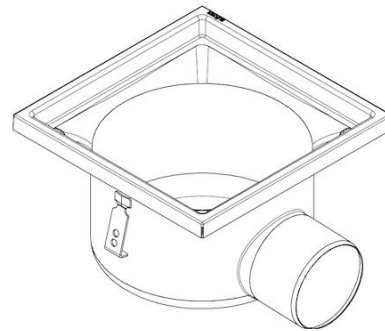
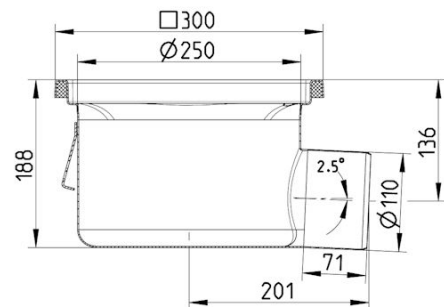

BLÜCHER®

A WATTS Brand