

676CT070-35CF S HYGIENICPRO CHANNEL 150x7000 CENTER OUTLET

- Low model. With outlet box
- Floor: concrete, tiled and resin
- No membrane
- Outlet: Ø110mm, horizontal
- Stainless steel: AISI316L/EN1.4404

Product Codes

UPC/EAN: 5705499137361
VVS Number:
RSK Number:
NRF Number:
LVI Number: 3305730

Specification

Brand Name: BLÜCHER
Floor: Concrete/tiled/resin
Material: AISI 316L
Material (EN): EN 1.4404
Membrane Type: No membrane
Minimum Height (mm): 319
Outlet Box: Yes
Outlet Diameter (mm): 110
Outlet Direction: Horizontal
Outlet Placement: Center
Series: Channel-No membrane
Size: 150x7000
Type: Channels
Weight (kg): 56,94

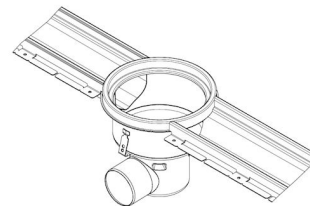
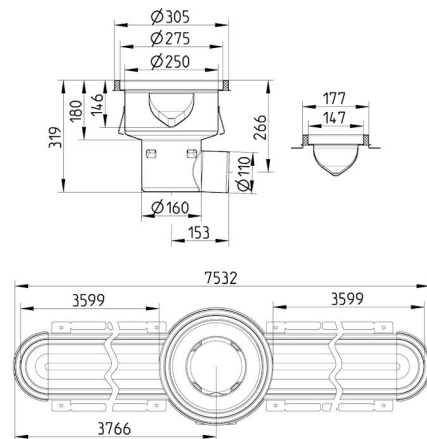

BLÜCHER®

A WATTS Brand